

Article number: 60415221018

Description: Timing Belt Pulley 21 AT5 18/2

Measures

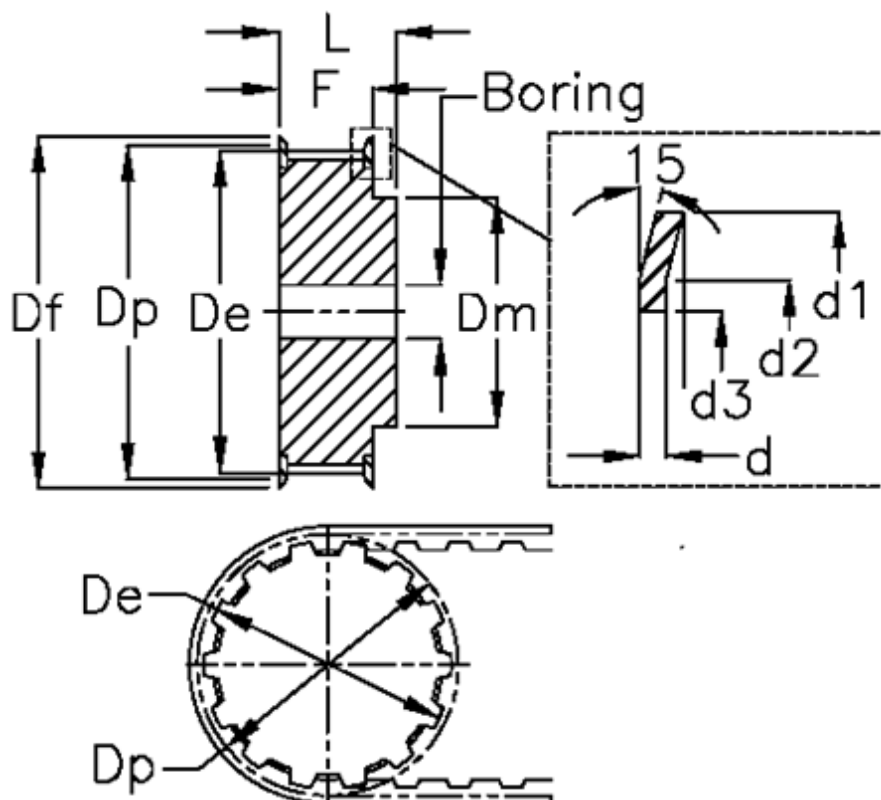

Belt width = - 10 mm	Dp	= 28.66
d = 1	F	= 15
d1 = 32	Flange type	= F10
d2 = 27.5	L	= 21
d3 = 23	Pre-drilled	= 6
De = 27.4	Tooth number	= 18
Df = 32	Type	= AT5
Dm = 20	Weight	= 0.031